

Auberry









FREESTANDING ELECTRIC STOVE

AUB20



Auberry

Features

-  Unique Optimyst effect
-  2kW heat output
-  Choice of 2 heat settings
-  Thermostat
-  Flame effect only
-  Remote control
-  Log effect fuel bed
-  Opening doors
-  Freestanding - quick & easy to install

Auberry



Remote Control



Fuel Bed



Logs

Auberry

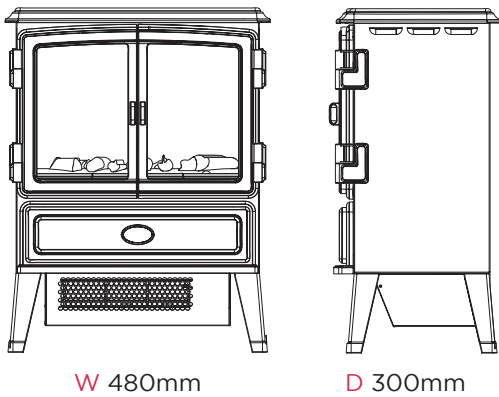

W 480mm

D 300mm

H 620mm

Dimensions & Weight

Height (mm)	Width (mm)	Depth (mm)	Weight (kg)
620	480	300	17

Product Features

Heat Output	2kW
Heat Settings	2 - 1kW / 2kW
Variable Thermostat	Y
Fan Heat / Radiant Heat	Yes / No
Location of Controls	Behind doors
On/Off Switch	Y
Remote Control	Y
Batteries Included	Y (AAA)
Optimyst Effect	Y
Flame Type	Optimyst
Water Tank Size	1.1 Litre
Fuel Bed Supplied	Logs

Accessories

HPD001 Hearth Pad	X-025951
-------------------	----------

Product Features

Product Category	Electric Fires
Product Type	Stove
Brand	Dimplex
Model/Range Name	Auberry
Flame Effect	Optimyst
Model Reference	AUB20
Material Code	X-049889
Barcode	5011139049889
Approvals	CE/UKCA
Guarantee Period	2 years

Product Features

Lot 20 Compliant	Y
Freestanding	Y
Wall Mountable	N
Inset	N
Opening Doors	Y
Suite	N
Lamp Type	4 x 50W Amber Xenon
Kettle (IEC) Lead	Y
Safety Cut Out	Y
Power Cord Length	1.8m
Core Materials	Steel/Plastic/Glass
Finish / Colour	Cream